

In-correct ring-bolt placement. Ring can be twisted in a fall resulting in glue bond failure.

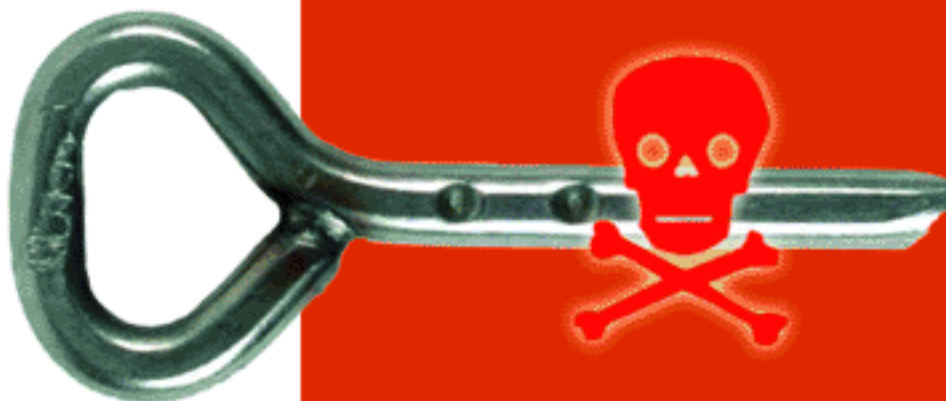







Correct ring-bolt placement. Ring is well recessed into rock notch and unable to be twisted. Glue fills the notch to the rock surface.

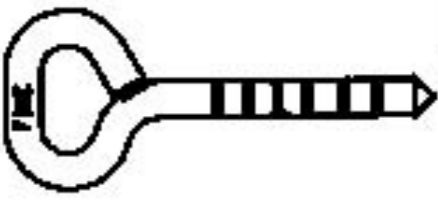

Only use glue from an injection gun when placing ring-bolts. Capsules do not contain enough glue to fill the notch for the 'eye ring'.

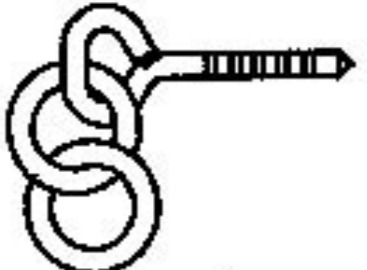
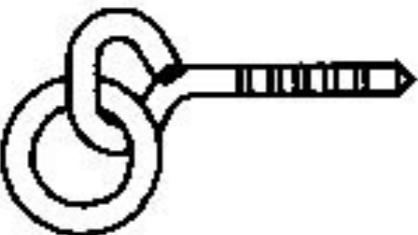
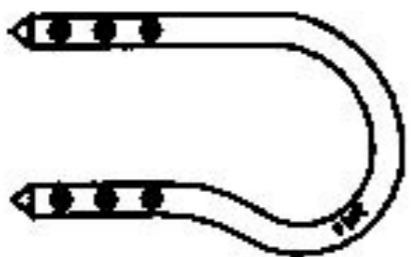
USO-USAGE-USE

REF 	REF 	ANCLAJES AMARRAGES ANCHORS
	014A 541 326 014AM	
014C 014CM		
	403	
	344	
	014B 014BM	
	014D	

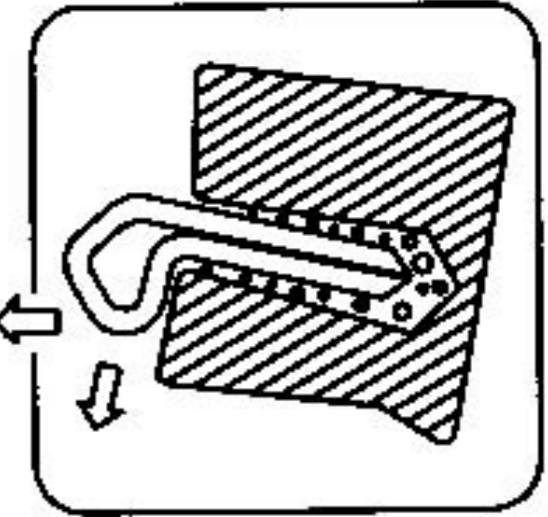
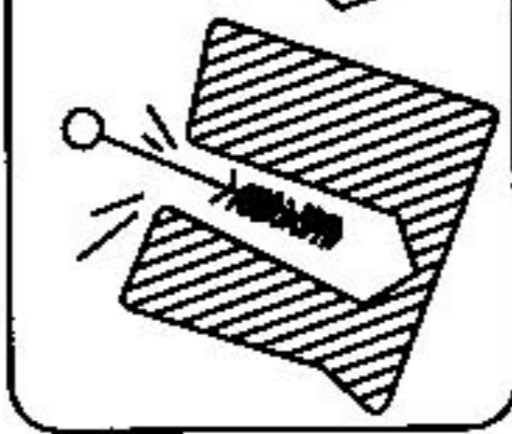
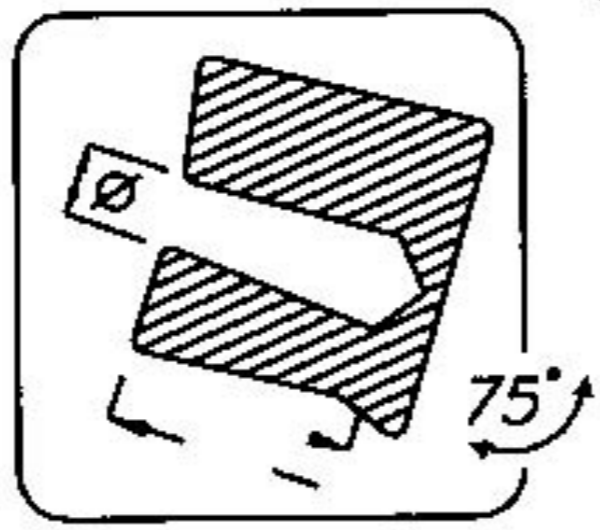
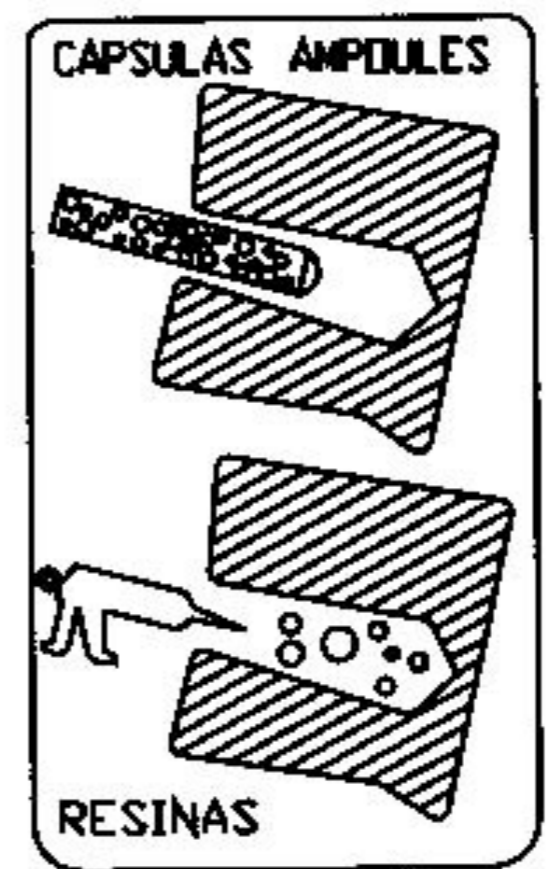
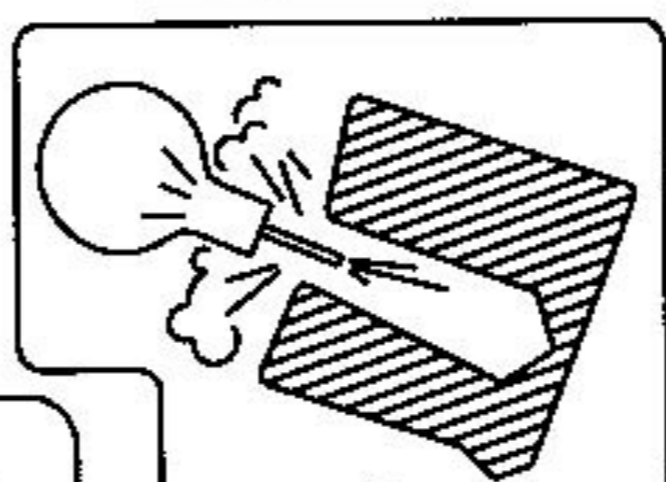
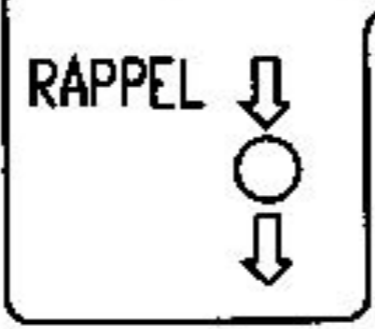
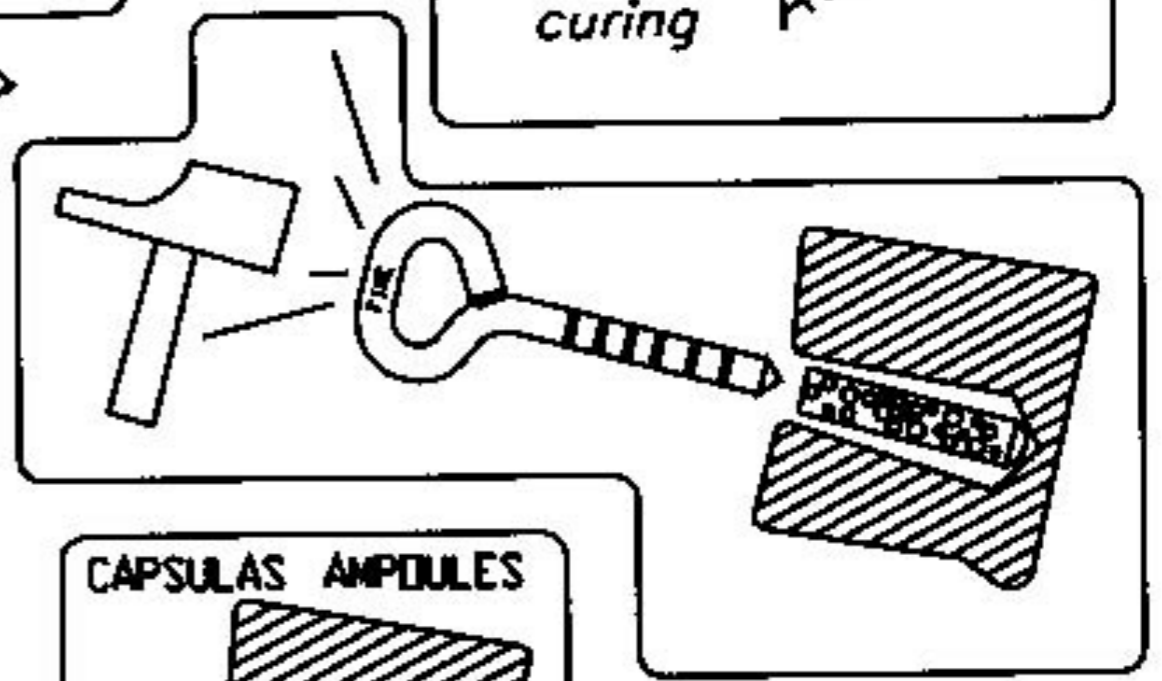
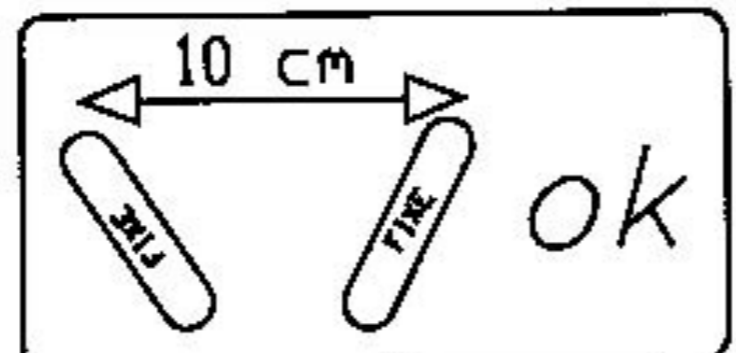
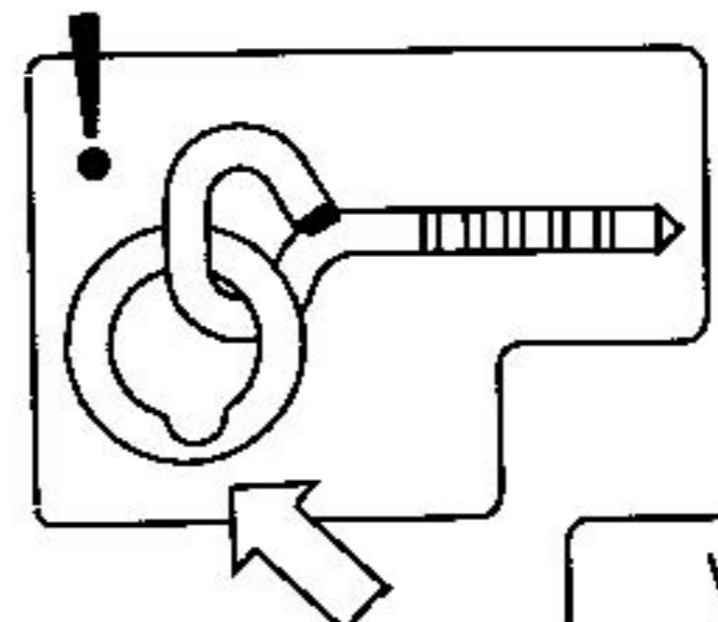
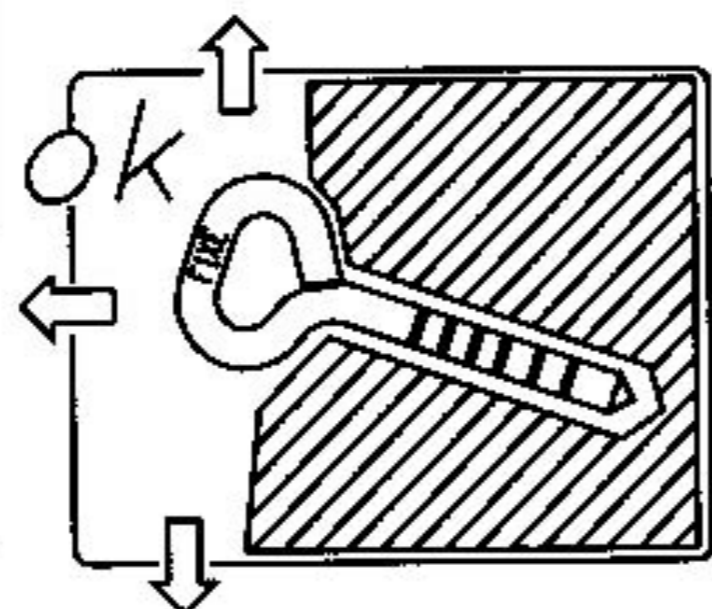

1°

2°

3°

4°